



Great Wall Trading

Casting, Forging and Aluminum Parts

Quality and Service are Our First Priority

96 Bowes Rd, Unit 4
Concord, Ont. L4K 1J7

tel. 647-547-6621

cell. 416-803-3361

fax. 647-547-6621

email. greatwalltrading@rogers.com



Samples of Work Done By Our Company



Forged Bars

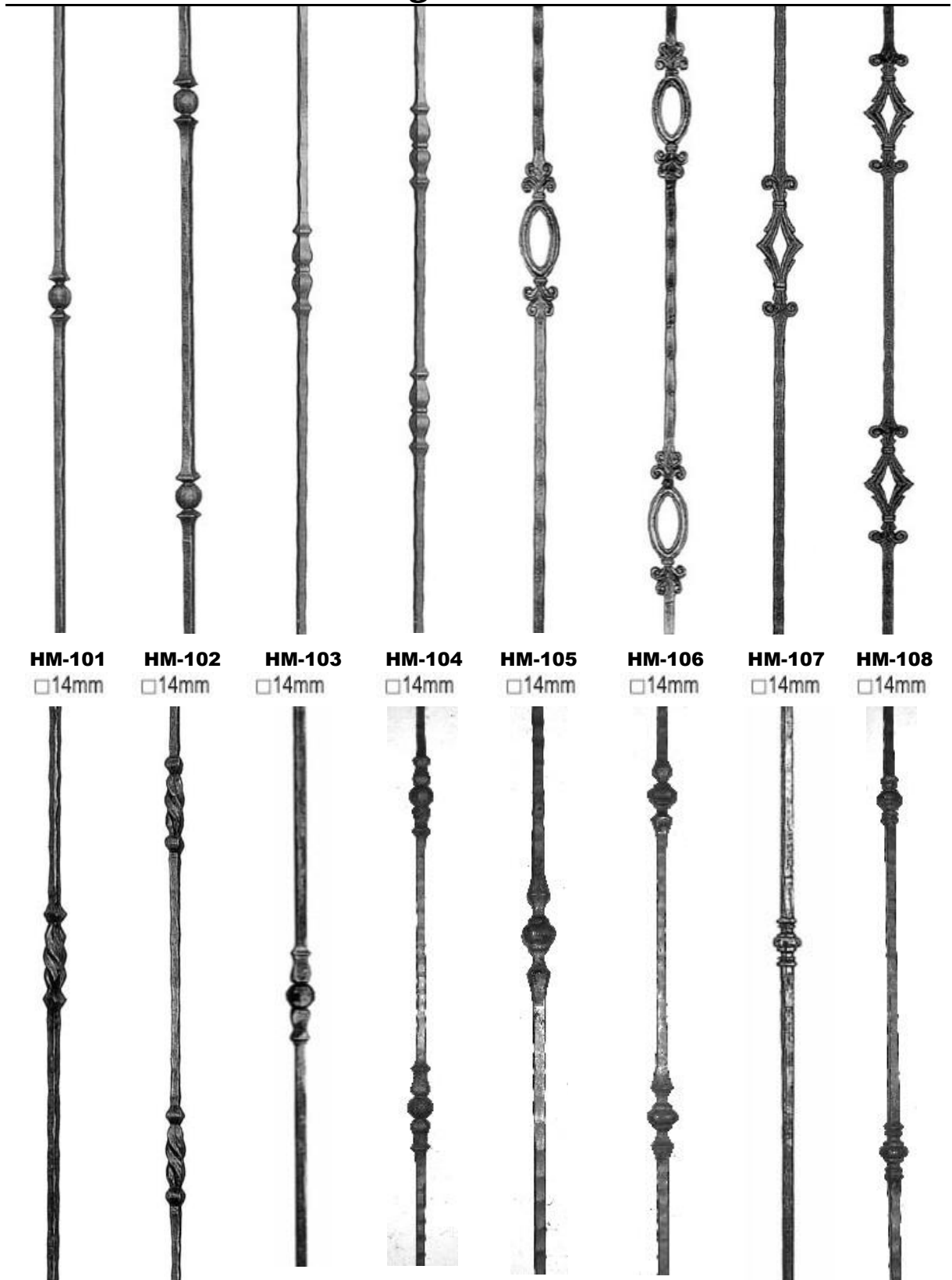

Forged Bars



HM-117
■ 1/2"



HM-118
■ 1/2"



HM-119
■ 1/2"



HM-120
■ 1/2"



HM-121
■ 1/2"



HM-122
■ 1/2"



HM-123
■ 14mm



HM-124
■ 14mm



HM-125
□ 14mm



HM-126
□ 14mm



HM-127
□ 14mm



HM-128
□ 14mm



HM-129
□ 14mm



HM-130
□ 14mm



HM-131
□ 1/2"



HM-132
□ 1/2"

Forged Bars

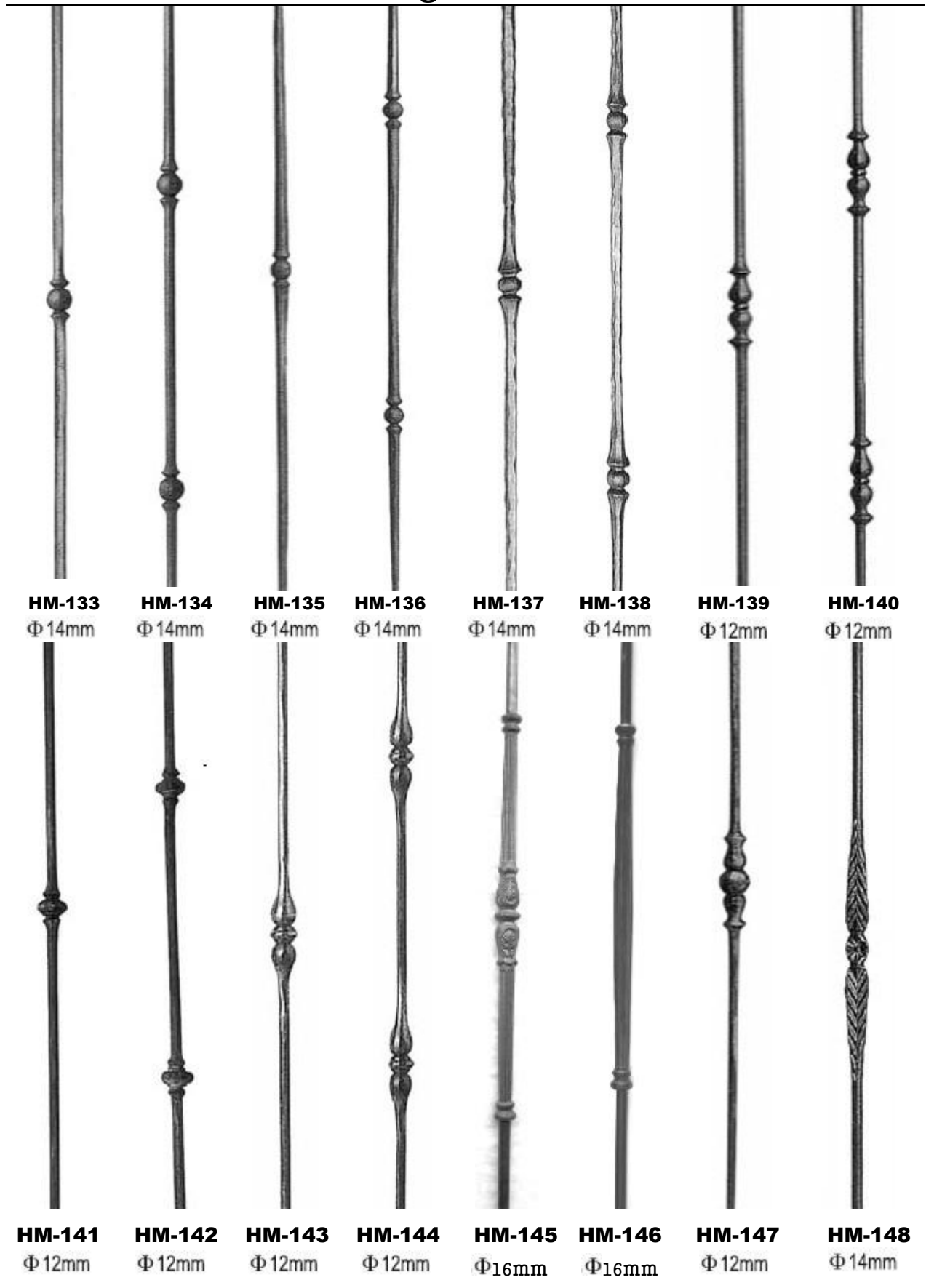

Forged Bars

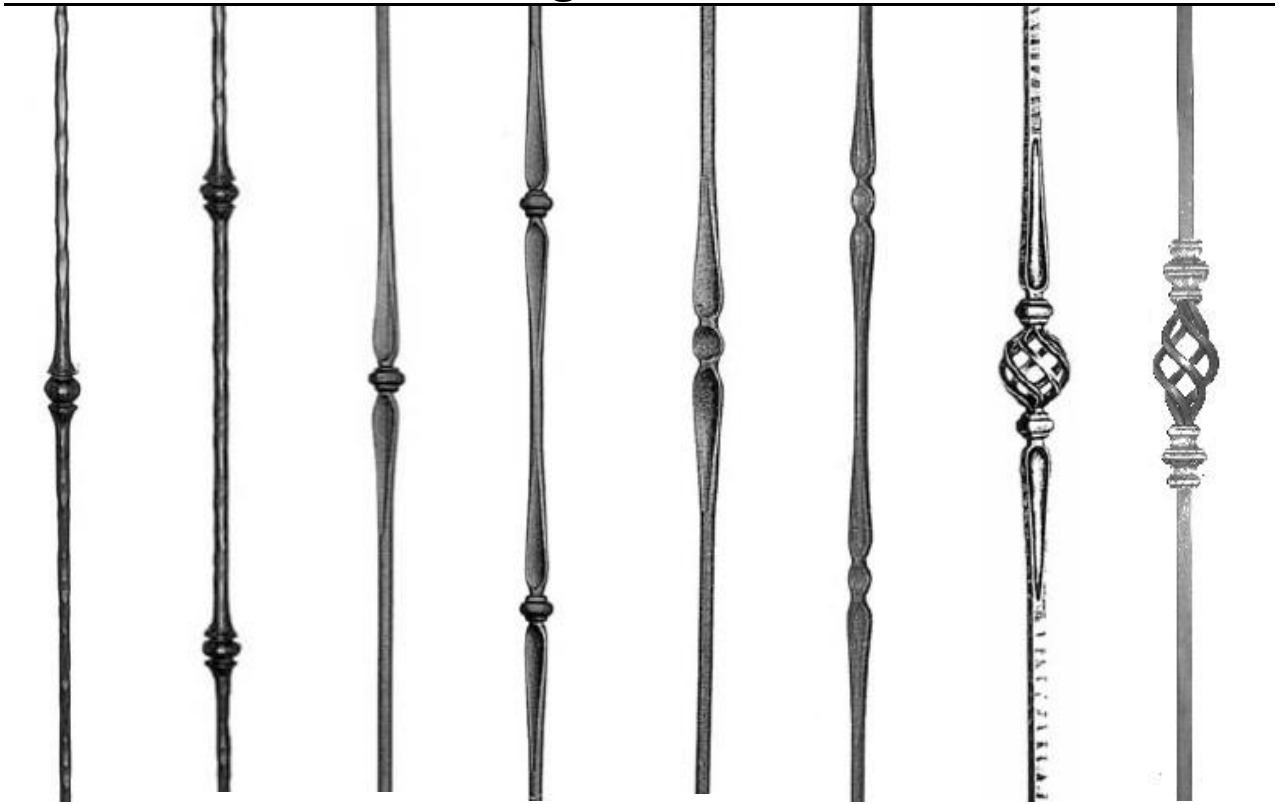

HM-149
Φ 14mm

HM-150
Φ 14mm

HM-151
Φ 14mm

HM-152
Φ 14mm

HM-153
Φ 14mm

HM-154
Φ 14mm

HM-155
Φ □ 14mm

HM-156
□ 1/2"

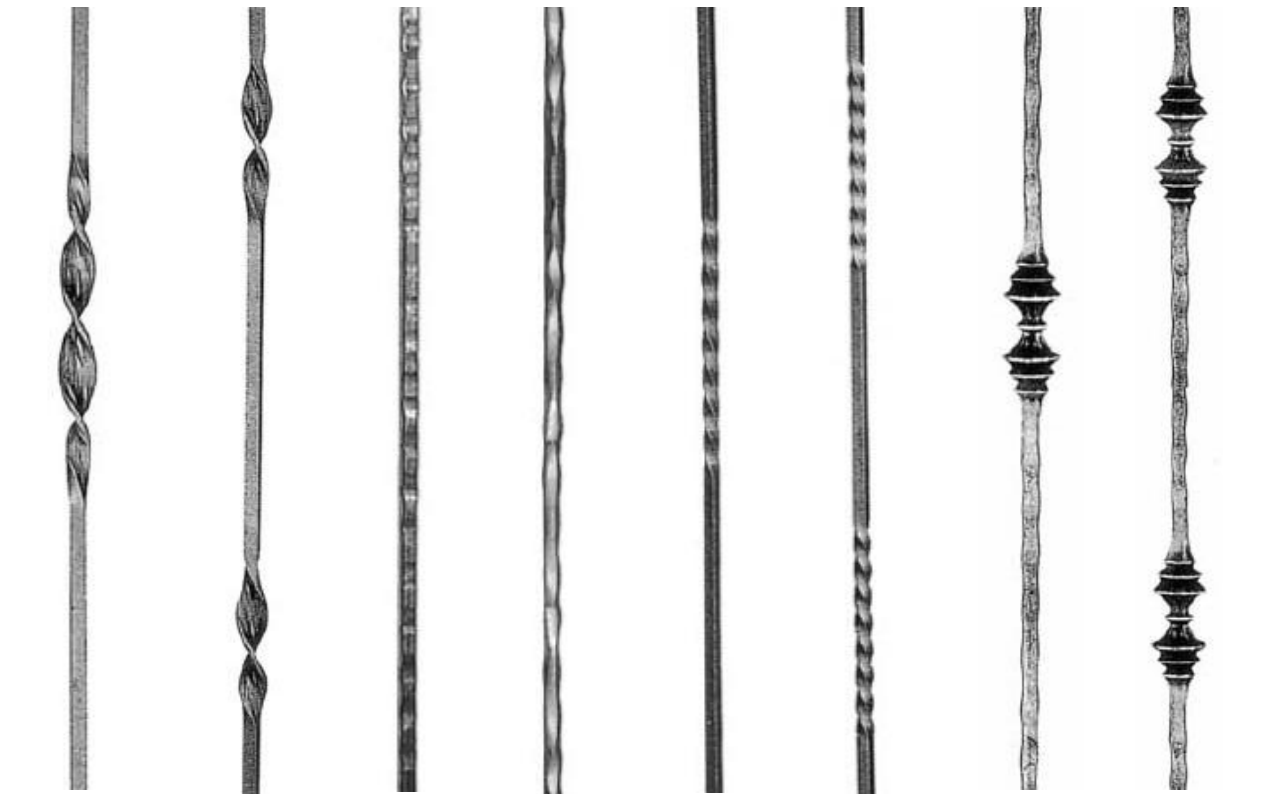

HM-157
□ 12mm

HM-158
□ 12mm

HM-159
□ 14mm

HM-160
□ 14mm

HM-161
□ 1/2"

HM-162
□ 1/2"

HM-163
□ 14mm

HM-164
□ 14mm

Forged Bars



HM-165
□14mm



HM-166
□14mm



HM-167
□14mm



HM-168
□14mm



HM-169
□ 1/2" Plain



HM-170
□ 1/2"



HM-171
■16mm



HM-172
■16mm



HM-173
□14mm



HM-174
□20mm



HM-175
■1/2"



HM-176
□14mm



HM-177
□14mm



HM-178
■1/2"



HM-179
■20x4mm



HM-180
■20x4mm

Forged Bars



HM-181
■ 1/2"



HM-182
■ 1/2"

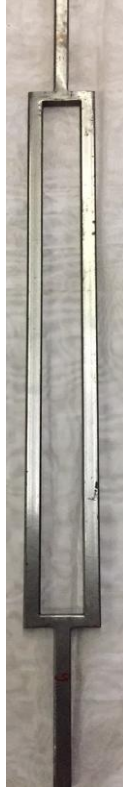

HM-183
■ 1/2"



HM-184
■ 12mm



HM-185
■ 12mm



HM-186
■ 12mm



HM-187
■ 14 mm



HM-188
■ 14 mm



HM-189
■ 12mm



HM-190
■ 12mm



HM-191
■ 1/2"

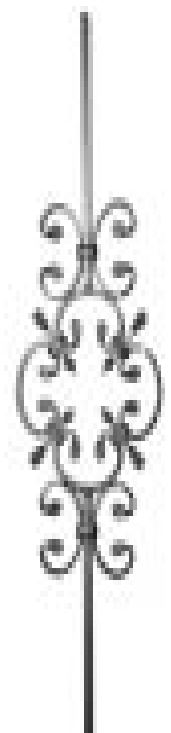

HM-192
■ 1/2"

Forged Posts



HM-201
42"



HM-202
48"



HM-203
6x48"
Hexagon



HM-204
6x58"
Hexagon



HM-205
47-1/4"
■ 1"



HM-206
47-1/4"
■ 1"



HM-207
47-1/4"
■ 1"



HM-208
47-1/4"
■ 1"



HM-209
47-1/4"
■ 1"



HM-210
47-1/4"
■ 1"



HM-211
47-1/4"
■ 1"



HM-212
47-1/4"
■ 1"

















HM-213
47-1/4"
■ 1"



HM-214
47-1/4"
■ 1"

Forged Posts

| | | | | | | |
|---|---|---|---|--|---|---|
|  |  |  |  |  |  |  |
| HM-215 47-1/4" ■ 1" | HM-216 47-1/4" ■ 1" | HM-217 47-1/4" ● 1-3/16" | HM-218 47-1/4" ● 1-3/16" | HM-219 47-1/4" ● 1-3/16" | HM-220 47-1/4" ● 1" | HM-221 47-1/4" ● 1" |
|  |  |  |  |  |  |  |
| HM-222 47-1/4" ● 1-3/16" | HM-223 47-1/4" ● 1-3/16" | HM-224 47-1/4" ■ 1" | HM-225 47-1/4" ■ 1" | HM-226 47-1/4" ■ 1" | HM-227 47-1/4" ■ 1" | HM-228 47-1/4" ■ 1" |

Bars & Handrails



HM-229

■ 1 x 1/4" . 1/4x1-1/2" . 1/4x 1-1/4"



HM-230

■ 1/2" . 5/8" 24 ft



HM-231

1-3/4"



HM-232 Tubes

1" . 1-1/4" . 1-1/2" . 2"



HM-233

50 x14 mm . 10ft



HM-234

50 x14mm .19ft



HM-235

58 x 21mm . 19ft



HM-236

9.5ft.



HM-237

1 x 1/2" 20ft .



HM-238

1 x 1/2" 20ft . 10ft



HM-239

●9/16" & 5/8"



HM-240

HM-241

14 X 4mm



HM-242

Ending 2-1/4"

HM-243







HM-244

Ending 1-3/4"





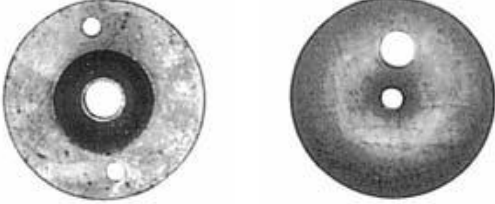
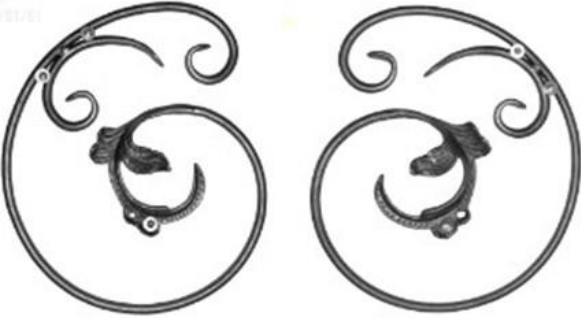
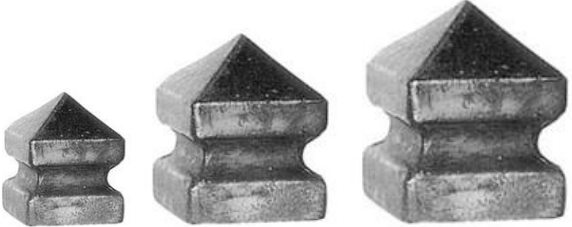





HM-245

Scrolls

| | | | |
|---|--|--|--------------------------------------|
|  |  | | |
| <p>HM-246 435 x 235mm. ■ 12mm</p> | <p>HM-247 325 x 185mm</p> | <p>HM-248 300 x 100mm. ■ 12mm</p> | <p>HM-249 450 X 100mm</p> |
|  |  | | |
| <p>HM-250 ■ 1" . 1-1/4" . 1-1/2" . 2" . 3" . 4"</p> | <p>HM-251 Φ3" . ● 1/2"</p> <p>HM-252 Φ3" . ● 1/2"</p> | | |
|  |  | | |
| <p>HM-253 ● 12mm 350 mm x 280mm</p> | <p>HM-254</p> <p>HM-255 ■ 2" . 3" & 4"</p> | | |
|  |  | | |
| <p>HM-256 220 X 175mm ■ & ● 12mm</p> | <p>HM-257 140 X 95mm</p> | <p>HM-258 310 X 225mm ■ 1/2"</p> | <p>HM-259 140 X 95mm</p> |

Scrolls

| | | |
|---|--|---|
|  |  | |
| <p>HM-260 ■ 12mm 310MM X 250MM.</p> | <p>HM-261 ■ 16 x 8mm. 310MM X 250MM.</p> | |
|  |  | |
| <p>HM-262 Fit 1-3/4"</p> | <p>HM-263 Fit 1-3/4"</p> | |
|  |  | |
| <p>HM-264 Fit 2-1/4"</p> | <p>HM-265 Fit 2-1/4"</p> | |
|  |  |  |
| <p>HM-266</p> | <p>HM-267</p> | <p>HM-268</p> |

SCROLLS AND FORGED PIECES



HM-301
 ■ 1/2X1/4"
 □ 1/2" x44"



HM-302
 ■ 1/2X1/4"
 □ 1/2" x44"



HM-303
 34-1/4"X13-3/4" ■ 1/2X1/4"
 Hammered



HM-304
 34-1/4"X13-3/4" ■ 1/2X1/4"
 Not Hammered



HM-305
 H6"XL2-3/4"
 ■ 1/2"X1/4"



HM-306
 H9"XL4-1/2"
 ■ 1/2"X1/4"















HM-307
 H9"XL4-1/2"
 ■ 1/2"X1/4"



HM-308
 H7"XL4-3/4"
 ■ 5/8"X5/16"

SCROLLS AND ROSETTES

| | | | |
|---|--|--|---|
|  |  |  |  |
| <p style="text-align: center;">HM-309 28-1/2"x9-1/2" ■ 3/4" x 1/4"</p> | <p style="text-align: center;">HM-310 33-1/2" X 9-1/2" X 4-1/2" ■ 3/4" X 5/16"</p> | <p style="text-align: center;">HM-311 H3-3/4"X2-5/8" ■ 1/2"X1/4"</p> | <p style="text-align: center;">HM-312 4-1/8"X2-3/4" ■ 1/2"X1/4"</p> |
|  |  |  |  |
| <p style="text-align: center;">HM-315 5-1/8" X 2-3/4" ■ 1/2"X1/4"</p> | <p style="text-align: center;">HM-316 5-1/2" X 3-3/4" ■ 9/16" & ■ 1/2"X1/4"</p> | <p style="text-align: center;">HM-317 5-15/16" X 3" ■ 1/2"X1/4"</p> | <p style="text-align: center;">HM-318 H11-1/2"Xw3"</p> |
|  |  |  |  |
| <p style="text-align: center;">HM-319 14x4mm</p> | <p style="text-align: center;">HM-320 14x4mm</p> | <p style="text-align: center;">HM-321 14x4mm</p> | <p style="text-align: center;">HM-322 ● 9-3/4" ■ 5/16"X5/16"</p> |

SCROLLS AND BULLNOSES



HM-323
 ■ 1/2"x1/4" H8"Xw3-1/4"



HM-324
 ■ 1/2x1/4" H8"Xw3-1/4"



HM-325
 ■ 1" X 1/4" X 44"



HM-326
 ■ 1"X 1/4 X 44"

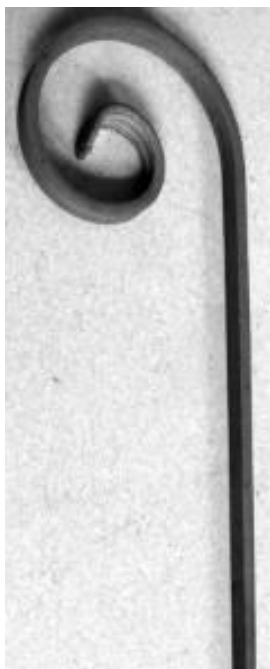

HM-327
 H15-3/4"xL4" ■ 1/2"X1/4"



HM-328
 H 7"XL2" ■ 1/2"X1/4"



HM-330
 H 7"X L2-1/2 ■ 1/2X1/4"



HM-331
 ■ 12mm 900X120mm

















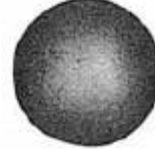
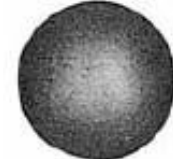



HM-332
 36"x4"x1/2"x1/4"



HM-329
 5/16"

SPHERES

| | | | |
|---|---|--|---|
|  |  |  |  |
| Smooth solid balls | Smooth solid balls | Smooth solid balls | Smooth solid balls |
| HM-333 Φ 9/16" | HM-334 Φ 3/4" | HM-335 Φ 1" | HM-336 Φ 1-1/8" |
|  |  |  |  |
| Smooth solid balls | Smooth solid balls | smooth solid balls | Smooth solid balls |
| HM-337 Φ 1-3/8" | HM-338 Φ 1-9/16" | HM-339 Φ 2" | HM-340 Φ 2-3/8" |
|  |  |  |  |
| Smooth solid balls | Smooth solid balls | Smooth solid balls | Smooth solid balls |
| HM-341 Φ 2-3/4" | HM-342 Φ 3-1/8" | HM-343 Φ 3-3/4" | HM-344 Φ 4" |
|  |  |  |  |
| HM-345 Φ 1" | HM-346 Φ 1-3/16" | HM-347 Φ 1-9/16" | HM-348 Φ 2" |
|  |  |  |  |
| HM-349 Φ 3/4" | HM-350 H.88mm L.28mm Φ 24mm | HM-351 H.120mm L.35mm Φ 30mm | HM-352 H.150mm L.42mm Φ 34mm |

BASES AND SHOES

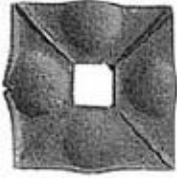

HM-353
□ 1/2" 2"x2"

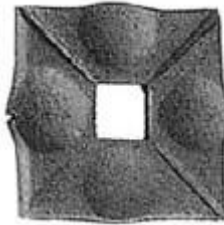

HM-354
□ 3/4" 2-3/4"x2-3/4"

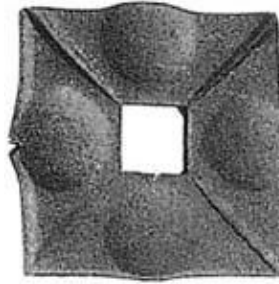

HM-355
□ 1" 3-1/2"x3-1/2"
□ 1-1/4" 4-1/4"x4-1/4"



HM-356
H1-1/4"x2" Φ 5/8"

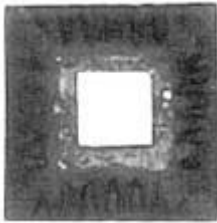

HM-357
□ 1" 3-1/8"x3-1/8"

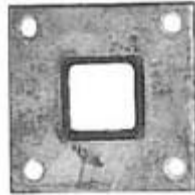

HM-358
□ 1" , 3"x3" Galvanized

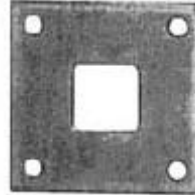

HM-359
□ 1" 3"x3"



HM-360
Base Φ 4-3/4" x1-5/8"

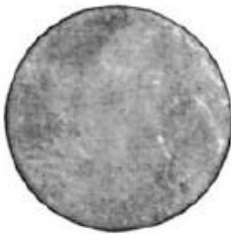

HM-361
Φ 3-1/4"x1/4"

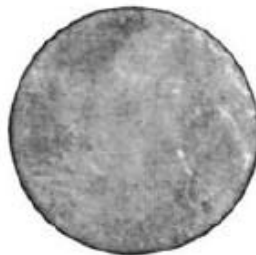

HM-362
Φ 4" x1/4"



HM-363
Base ○ 3-1/8"
Φ 1"



HM-364
Base Φ 3-1/8"
Φ 1-3/16"



HM-365
■ 9/16" H7"
Φ 3-1/2"



HM-366
■ 9/16" H7"
Φ 3-1/2"



HM-367
■ 9/16" H7"
Φ 3-1/2"



HM-368
□ 9/16" H1"xL2"x2"

GATE ACCESSORIES



HM-369

4-1/8"x11-1/4"x1-3/16"
≠ 1/8"



HM-370

5-1/4"x2-3/4"



HM-372

5-3/4"x3"

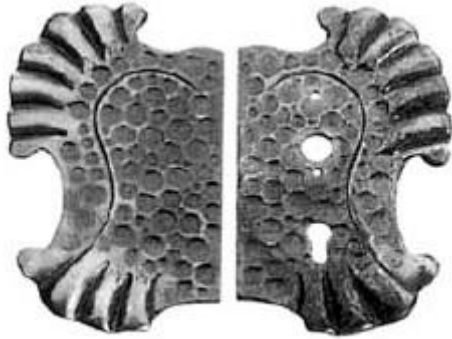

HM-371

10-1/2"x6-1/4"
≠ 1/8"



HM-374

5-3/4"x3"



HM-373

10-1/2"x6-1/4"
≠ 1/8"



HM-375

L6-3/4" x H3"

GATE ACCESSORIES AND LEAVES



HM-377 **HM-377**
 $\Phi 65\text{mm}$ $\delta \neq 2$ $\Phi 65\text{mm}$ $\delta \neq 2$



HM-379 **HM-379**
 $\Phi 50\text{mm}$ $\delta \neq 2$ $\Phi 50\text{mm}$ $\delta \neq 2$

HM-380
 H 280 X 50 mm

HM-380A
 H 450 x 195mm

HM-381
 7" X 1-3/4"



HM-382 14x 8mm



HM-382A
 150x80x4mm



HM-383
 $\frac{1}{2}$ " $\frac{1}{2}$ " X $\frac{1}{4}$ " $\Phi 4$ "

HM-384
 A H 160 X40mm 1/8

HM-384A
 $\Phi 105$ X 4mm

HM-385
 H 280 X L 50mm
 H 470 X L120mm

HM-386
 11-1/2" X2-1/4"

HOT STAMPED LEAVES



HM-387
H4" X L1-5/8"



HM-388
H4" X L1-5/8"



HM-389
H2-1/2" X L2-3/4"



HM-390
H2-1/2" X L2-3/4"



HM-391
H4" X L2-1/2"
≠ 1/8"



HM-392
H4" X L2-1/2"
≠ 1/8"



HM-393
H6" X L2-3/8"
≠ 1/8"



HM-394
H6" X L2-3/8"
≠ 1/8"



HM-395
Φ1-1/16" H5-3/4"



HM-396
3/4" H 2-3/4"



HM-397
Φ1" 3-1/8"



HM-398
Φ1-3/8" 4-3/4"



HM-400
L 20-3/4" X 3-1/8" Φ 1/2"

Wrought Iron



HM-400 A 115mm x 680mm. ■ 16 x 8mm



HM-400 B. ■ 1/2" 530 mmx 80mm.



HM-400 C. ■ 16 x 8mm 530 x 80mm.

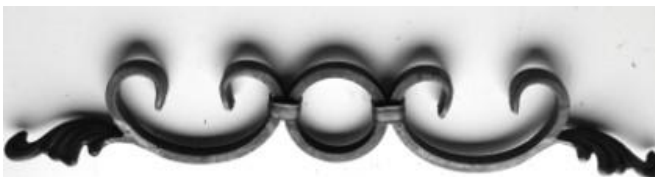

HM-400 D. ■ 12 x 8mm 530 x 80mm.



HM-400 E ■ 12 X6mm 100mm x 445mm.



HM-400 F ■ 12 x 6mm 100mm x 595mm .



HM-400 G 80 x 580mm Φ 1/2"



HM-400 H
Φ12 H 900 X L 13 mm

CAST IRON AND STEEL



HM-401
■ 1/2"



HM-402
■ 1/2" 2 Hole



HM-403
■ 1/2" screw



HM-404 Steel
■ 1/2" 5/8" 3/4" 1"



HM-405
■ 3/4"



HM-406
■ 1"



HM-407
■ 1/2" 3/4"X1-1/2"



HM-408
■ 3/4" 1"X2-1/4"



HM-409
■ 1" 1-1/8X2-1/2"



HM-410
■ 5/8" 1-1/8"x1-3/4"



HM-411
■ 1/2" 4"X2"



HM-412
■ 3/4" 4"X2"



HM-413
■ 1/2" 4-3/4"X3"



HM-414
■ 3/4" 6"X3-3/4"



HM-415
■ 1/2" 4"X1"



HM-416
■ 3/4" 4"X1-1/4"

CAST IRON



HM-417
 ■ 1/2" 3" X 1-1/2"



HM-418
 ■ 1/2" 1" X 1"



HM-419 " . 4-1/4"X4"
 ■ 1/2" . 5/8"



HM-420
 ■ 1/2" 16"X 7"



HM-421
 28" X 7"



HM-422
 17-1/2" X 7-1/2"



HM-423
 690 mm x 375mm



HM-424
 690mm x 375mm



HM-425
 13-1/2"X6-3/4"



HM-426
 15-1/4"X 8-1/4"



HM-427



HM-428
 □ 1" 2-3/4"x1-1/4"



HM-429
 □ 1-1/4" 2-3/4x1-3/4"



HM-430
 □ 1-1/2" 3-1/4"x2"



HM-431
 □ 2" 3-3/4"x2-1/2"



HM-432
 □ 2-1/2" 4-1/4"x3"

CAST IRON



Steel & iron



HM-433

Φ 3-1/2"

HM-434

Φ 5/8" . □ 1/2"

HM-435

1/2" 4X3-3/4"

HM-436

3/4" 4"X4"



HM-437

□ 1/2" 3X1-1/2"

HM-438

3-1/2" X 1-3/4"

HM-439

1/2" 50 x40mm

HM-440

1-1/2"X 3/4" Φ 1/2"



Cast steel & iron



HM-441

□ 1/2" 4X1-3/8"

HM-442

3-1/4"x3-1/4"

HM-443

□ 1/2" 2HOLE

HM-444

□ 1/2"

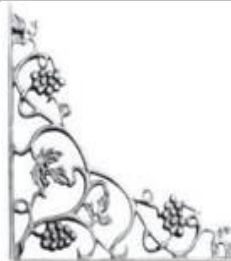

HM-445 solid

■ 1" 1-1/4" 1-3/4"

HM-446

15-1/2" X 15-1/2"

HM-447

15-1/2" X 15-1/2"

HM-448

15-1/2" X 15-1/2"

CAST IRON



HM-449
2-1/2" & 3"



HM-450
3-1/2"



HM-451
4"



HM-452
4-1/2"



HM-453
6"X 1-3/4"



HM-454
6"X2-1/4"



HM-455
4-1/4"X1-3/4"



HM-456
4-3/4"X2-1/4"



HM-457
1-3/8"x1-1/4" Φ 1/2"



HM-458
 Φ 9/16" & Φ 5/8"



HM-459
 Φ 5/8"



HM-460
 Φ 9/16" & 1/2"



HM-461
 \square 1/2"



HM-462
 Φ 5/8" H1"X1-1/4"



HM-463
 Φ 9/16" H1"X1-1/4"



HM-464
 Φ 1/2" H1"X1-1/4"

VICTORIAN DESIGNS



HM-465



HM-466
22" X 7"



HM-467
31" X 6"



HM-468
28" X 7"



HM-469
27-1/2" X 6-3/4"



HM-470
H27-1/2" X 6-3/4"



HM-471
H30" X W6-1/4"



HM-472
H25" X W6-1/2"



HM-473
31" X 4"



HM-474
22" X 5-1/2"



HM-475
28-1/2" 4-3/4"



HM-476
28" X 7"



HM-477
40" X 6"



HM-478
H32-1/2" X 8-1/2"



HM-479
H40" X 8-1/4"

VICTORIAN DESIGNS (and Misc.)



HM-480
28-1/2" 4-3/4"



HM-481
27" X 23"



HM-482



HM-483
Mail Box



HM-484



HM-485



HM-486



HM-487



HM-488

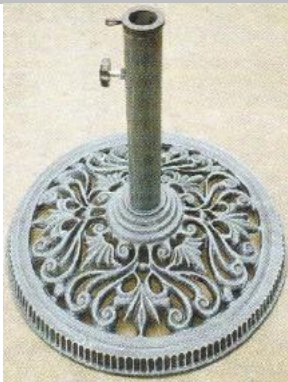

HM-489



HM-490



HM-491
Mail Box



HM-492
MAIL BOX

Cast Iron



HM-493
Φ 55mm



HM-494
110 x 110mm



HM-495
160 x 160 mm



HM-496
170 x 170mm



HM-497
Φ 105



HM-498
Φ 85mm



HM-499
Φ 50mm



HM-500
Fit 1/2"



HM-501



HM-502



HM-503
□ 3/4"



HM-504
Φ1/2" . Φ5/8"



HM-505
Φ1/2" 152x52mm



HM-506
Φ5/8" 210 X 58mm



HM-507
690 X 275mm

Cast Iron



HM-509
780 x 340mm



HM-508
735 x 460mm



HM-510
735 x 460mm



HM-511
560 x 175mm



HM-512
755 x 250mm



HM-513
580 x 260 mm



HM-514
190 X 740mm

Forged Panels



HM-515
1000 x480mm



HM-516



HM-517
870 x285mm Φ 14mm



HM-518
870 X 350 . \blacksquare 12 x6mm



HM-519
 \blacksquare 12 850 X 320mm



HM-520
 \blacksquare 12 760 X 380mm

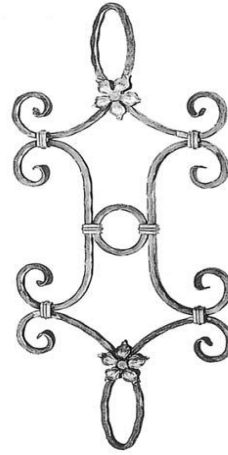

HM-521
 \blacksquare 12 900x 380mm



HM-522
 \blacksquare 30x12. 650X 270mm



HM-523
Plain & Hammered



HM-524
150 x40mm



HM-525
Fit $\frac{1}{2}$ "
95 x 95mm . 12x6mm



Φ 30.40.50.60.70.80.
100.120. 150. 180. 200mm

HM-526
Hollow steel balls
Thickness 3mm

Forged Panels

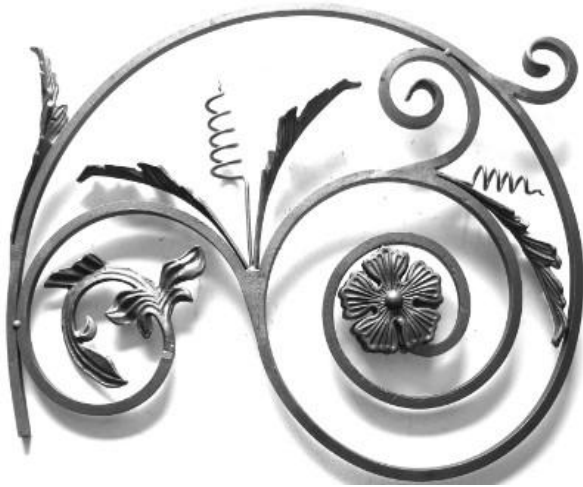

HM-527
 ■ 1/2" L 725 x700mm

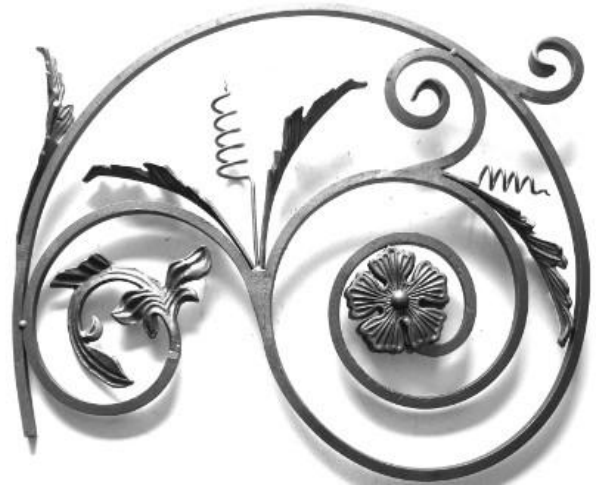

HM-528
 ■ 1/2" R 725 x700mm



HM-529
 Φ1/2" L 725 x700mm



HM-530
 Φ1/2" R 725 x700mm



HM-531
 ■16x 8mm 900x420mm



HM-532
 ■16x 8mm 900x420mm

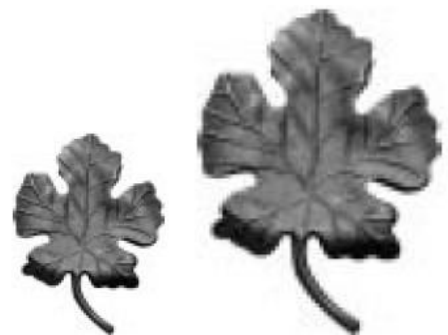

HM-533
 155 X 115 & 115 X 75mm



HM-534

H 30-1/2" x L 55" 1/2" sq

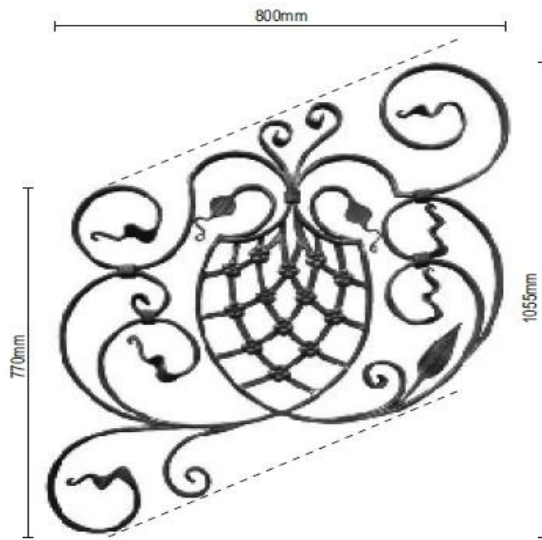

HM-535 H 1055 X L800mm 25 x 8mm



HM-536 H855 X L800mm 25X8mm



HM-537

MALLEABLE CAST STEEL



HM-601
6" X 5-1/16"



HM-602
6" X 5-1/16"



HM-603
6" X 4-3/4"



HM-604
6" X 4-3/4"



HM-605
8" X 4-1/8"



HM-606
8" X 4-1/8"



HM-607
9" X 5-1/8"



HM-608
9" X 5-1/8"



HM-609
9-5/16" X 5-3/4"



HM-610
9-5/16" X 5-3/4"



HM-611
6-1/4" X 2-3/4" steel



HM-612
6-1/4" X 2-3/4" steel



HM-613
7" X 3-1/2" steel



HM-614
7" X 3-1/2" steel



HM-615
10' X 5-1/4" steel



HM-616
7" X 3-1/4" steel

CAST STEEL



HM-617
4-3/4" steel



HM-618
3"X3" & 5X5" steel



HM-619
Φ3" steel



HM-620
2-1/2" steel



HM-621
155 X 115 & 115 X 75mm



HM-622
Fit 16mm



HM-623
Φ 3-1/2"



HM-624
Φ 3-1/2"



HM-625
Φ2 -1/2" 0.07KG



HM-626
□ 1/2"



HM-627
□1/2" φ 5/8"



HM-628
5-1/4"X 4-1/2"



HM-629
Φ 4-1/4" 0.33KG



HM-630
Φ1/2" H 5" X2-1/2"



HM-631
Φ H6"X2-3/4"



HM-632
Φ H7-1/2"X3-1/2"

Cast Steel & Iron Leaves



steel

HM-633
H3"XW3"



HM-634
H5"X3-1/2" steel



HM-635
H5"X3-1/2" steel



HM-636
H5-1/4"XW3" Iron



Cast Iron

HM-637
H9" X W 5 1/4"



Cast Iron

HM-638
H9" X W 5 1/4"



HM-639



HM-640
150 x130 mm



Cast Iron

HM-641
H5 1/4"XW5-3/4"



Cast Iron

HM-642
H5 1/4"XW5-3/4"



Cast Steel & Cast Iron

HM-643
H5 1/2" XW 6-1/2"



Cast Steel & Cast Iron

HM-644
H5 1/2" XW 6-1/2"



Cast Steel & Cast Iron

HM-645
H3-3/4"xw4"



Cast Steel & Cast Iron

HM-646
H3-3/4"xw4"



Cast Steel & Cast Iron

HM-647
H6-1/2"xw8"



Cast Steel & Cast Iron

HM-648
H6-1/2"xw8"

Forged Cast Steel Leaves



HM-649
5-1/2"x2-1/2" 0.16kg



HM-650
7-1/2"x2-1/2" 0.47kg



HM-651
6-1/2"x3-1/2" & 8x4-1/4"



HM-652
5-1/4"x3" 0.34kg



HM-653
7-1"x5-1/2" 0.29kg



HM-654
4-3/4"x3" 0.2kg



HM-655
11-1/4"x6" 0.36kg



HM-656
11-1/4"x6-1/2" 0.32kg



HM-657
5-1/2"x4" 0.35kg



HM-658
□ 1/2"



HM-659
Handle for forklift



HM-660
Handle for forklift



HM-661
1-1/4" X 4"



HM-662
3-1/2"



HM-663
H3-3/4"X3" 0.23KG



HM-664
●1" 4-1/4" X 2-1/2"
●1-1/8" 5 x 2-1/2"
●1-1/4" 5-1/2 x 3"

Forged Steel Leaves



HM-665
H.45mm
Φ 30mm



HM-666
H.50mm
Φ 45mm



HM-667
H.70mm
Φ 55mm



HM-668
H.80mm
Φ 65mm



HM-669
165 x 60 mm Φ 24mm



HM-670
185 x 70 mm Φ 27mm



HM-671
212 x 80mm Φ 30mm



HM-672
150 x 40mm ■ 40mm



HM-673
180 x 60mm Φ 30mm



HM-674
170 x 56mm Φ 30mm



HM-675
205 x 70mm Φ 35mm



HM-676
160 x 25mm ■ 1"

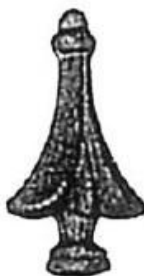

HM-677
Φ 20mm
80 x 45 mm



HM-678
Φ 25mm
125 x 65mm



HM-679
Φ 38mm
80 x 38mm



HM-680
H350 x M85mm
350 x 85mm

Scrolls & Forged



| | | | |
|--------------------------|------------------------------|---------------|--|
| HM-701 8" X 5" | HM-702 5-1/4" X 3" | HM-703 | HM-704 12-1/2" X 2-3/4" 12x6mm & 16x8mm |
|--------------------------|------------------------------|---------------|--|



| | | | |
|---------------|---------------|---------------------------|-------------------------------------|
| HM-705 | HM-706 | HM-707 Fit 1/2" | HM-708 ■ 1/2" H5"XW2-1/2" |
|---------------|---------------|---------------------------|-------------------------------------|



| | | | |
|---------------|---------------|--------------------------------------|-----------------------------------|
| HM-709 | HM-710 | HM-711 Φ5/8" H2-3/4"XW3/8" | HM-712 5/8" H2"XW1-1/2" |
|---------------|---------------|--------------------------------------|-----------------------------------|



| | | |
|--|--|--|
| HM-713 ● 1/2" 41-1/2X28-1/2" | HM-714 ● 1/2" 41-1/2X28-1/2" | HM-715 36"x18" ■ 1/2" . ■ 16x8 |
|--|--|--|

Scrolls and Panels

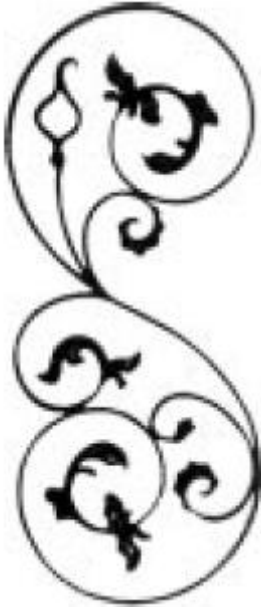

HM-716
5/8"x5/16" 14 X 6mm

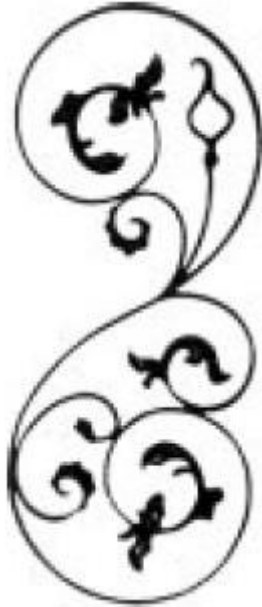

HM-717
5/8"x5/16" 14 X 6mm



HM-718
Φ14mm 31-1/2"x13"



HM-718A
H19-3/4" X W15-3/4"

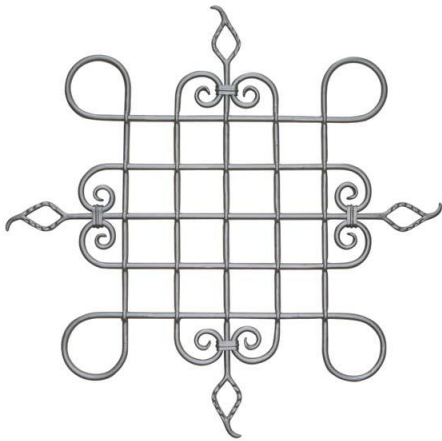

HM-719
32-1/2"x32-1/2" Φ1/2"

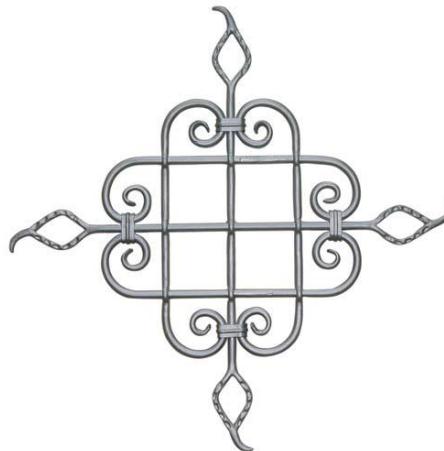

HM-720
32 "x 32" Φ1/2"



HM-720A
H19-3/4" X W15-3/4"



HM-721
1/2" 11X7-1/2"

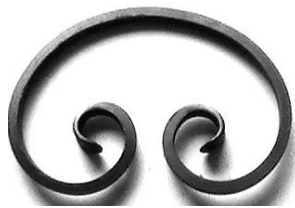

HM-722
1/2X1/4" 16-1/2X5-1/2"

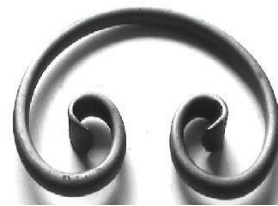

HM-723
9"X6-3/4"
■16 x 8mm. ●1/2"



HM-724
H10X4" Φ14mm

Flower Panels

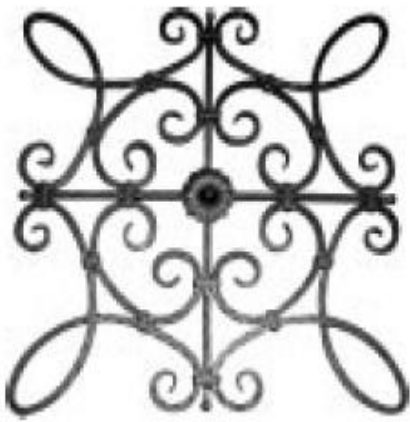

HM-725
 ■ 1/2" 26"X26"



HM-726
 28"X25-1/4" ■ 5/8"X 5/16"



HM-726
 ■ 12 x 6 400x280mm



HM-728
 ■ 1/2" 20-1/2"X17"
 Hammered



HM-729
 ■ 16 x 8mm 24" X 24"
 ■ 1/2" 31-1/2" x 31-1/2" Plain

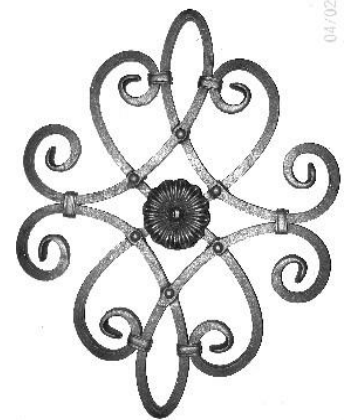

HM-730
 20-1/2"X17"
 ■ 1/2" Plain

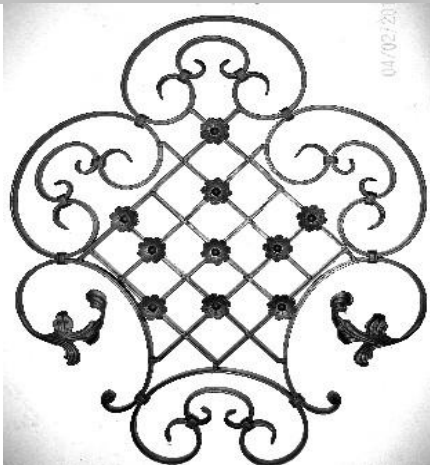

HM-731
 34"X28" ■ 5/8"X 5/16"



HM-732
 19"x16"



HM-733
 13-1/2"X7" 1/2"X1/4"

Flower Panels



HM-734

● 1/2" H34-1/2" x W22-3/4"

HM-735

● 1/2" H34-1/2" x W22-3/4"



HM-736

■ 5/8"X5-16" H31-1/2" x W18-1/8"



HM-737

■ 5/8"X5-16" 35-1/2"X11-3/4"



HM-738

■ 1/2" W27-1/4" X H 6-1/2"



HM-739

■ 1/2" W27-1/4" X H 7-1/8"



HM-740

■ 3/4"X1/4" H28-1/4" X W9-1/4"



HM-741

■ 3/4"X1/4" H30" X W10"

Flower Panels



HM-742

■ 5/8" X 5/16" H26" X W19-3/4"



HM-743

■ 5/8" X 5/16" H26" X W19-3/4"



HM-744

■ 5/16" H28-1/2" X W20"



HM-745

5/16" 19-3/4" X 17-1/2"



HM-746

5/16" H21" X W15-3/4"



HM-747

5/16" H26-3/4" X W 17-3/4"



HM-748

■ 5/16 ● 26" ● 22"



HM-749

■ 5/16 H26-1/2" X W20-1/4"



HM-750

■ 5/16 H26-1/2" X W19-3/4"

Forged Panels



HM-751

■ 5/16 ϕ 23-5/8"



HM-752

■ 5/16 ϕ 23-5/8"



HM-753

■ 1" H33" XW 17"



HM-754

■ 1" H33" XW 16-1/2"



HM-755

■ 1" H33" XW 16-1/2"



HM-756

● 1-3/16" H43" X W12-1/2"



HM-757 ■ 1/2" W35-1/2" X H 19-3/4"

■ 5/8" X 5/16" W35-1/2" X H 19-3/4"

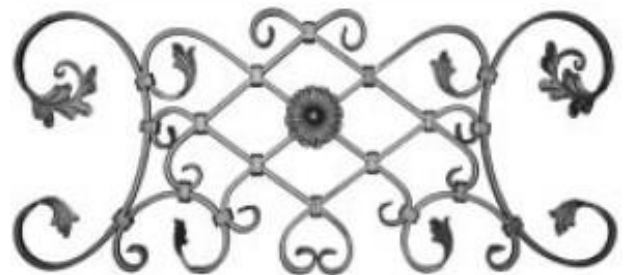

HM-758 ■ 1/2" W35-3/4" X H14-1/4"

■ 5/8" X 5/16" W35-3/4" X H14-1/4"

Forged Panels

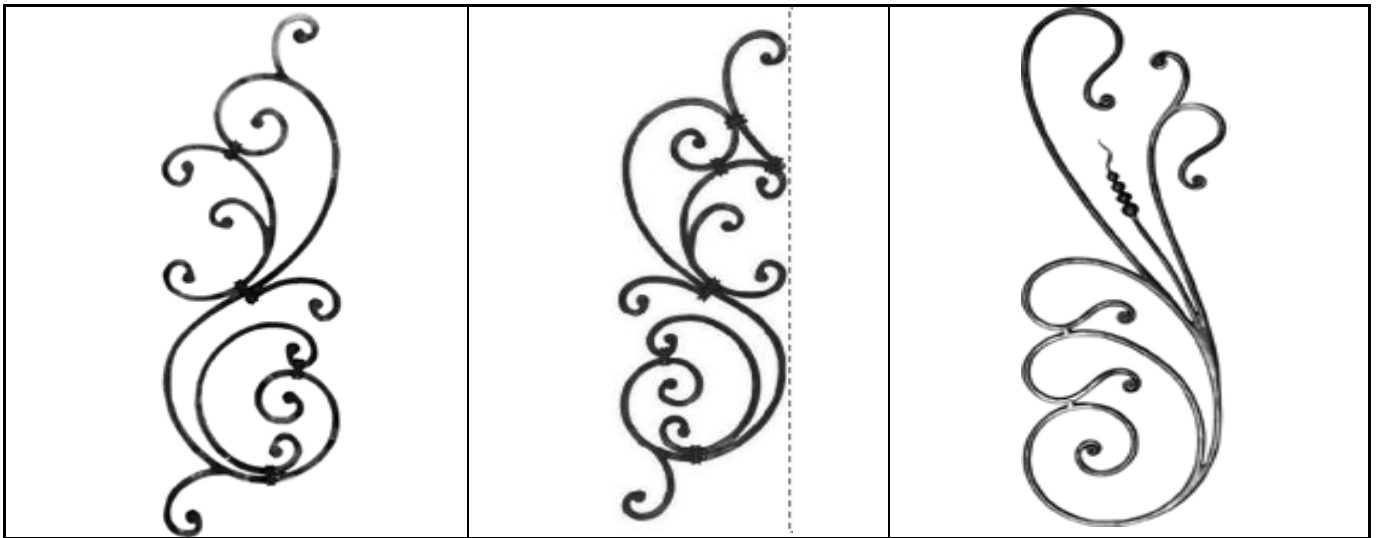

■ HM-759

■ HM-760

● HM-761

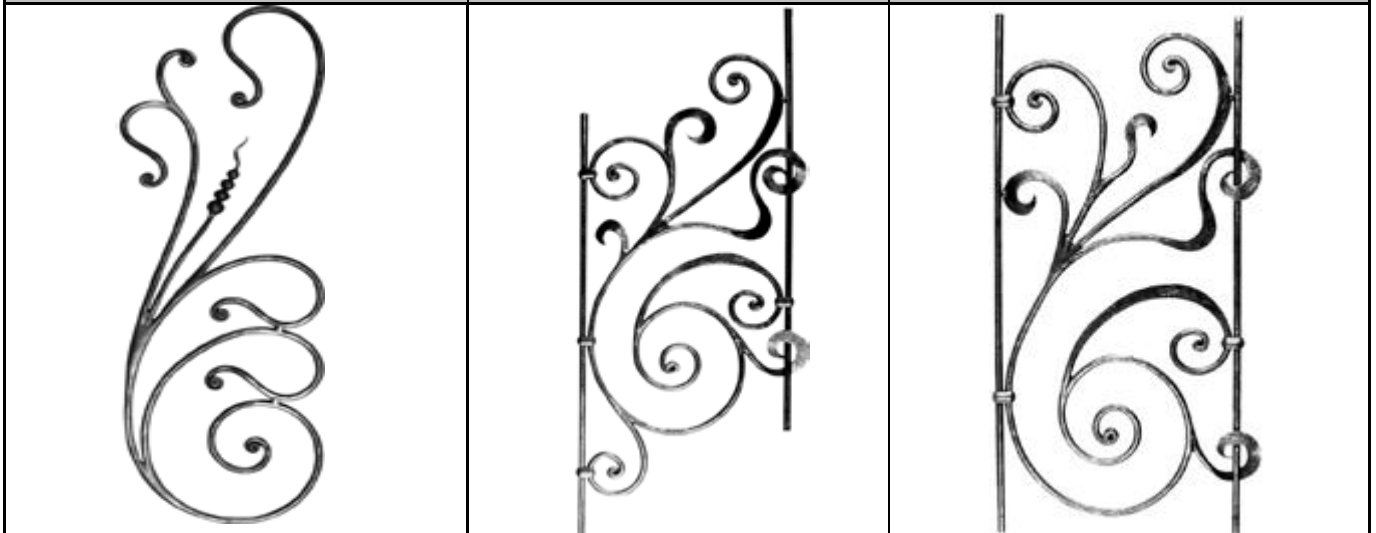

● HM-762

● HM-763

● HM-764



ALUMINUM SHOES AND BRACKETS

| | | | |
|---|---|--|---|
|  |  |  |  |
| <p style="text-align: center;">HM-811 3"</p> | <p style="text-align: center;">HM-812 1/2"</p> | <p style="text-align: center;">HM-813 1 1/4" . 1 1/2" . 2"</p> | <p style="text-align: center;">HM-814 9"X9" 7-14"X7-1/4"</p> |
|  |  |  |  |
| <p style="text-align: center;">HM-815 4"</p> | <p style="text-align: center;">HM-816 5/8" & 9/16"</p> | <p style="text-align: center;">HM-817 3" . 2-1/2. 2"</p> | <p style="text-align: center;">HM-818 1070 x 755mm</p> |
|  |  |  |  |
| <p style="text-align: center;">HM-819 ■ 1/2"</p> | <p style="text-align: center;">HM-820 ■ 1/2"</p> | <p style="text-align: center;">HM-821 ■ 1/2"</p> | <p style="text-align: center;">HM-822 Φ 4"</p> |
|  | |  | |
| <p style="text-align: center;">HM-823 30"X6-1/4"</p> | | <p style="text-align: center;">HM-824 35"X5"</p> | |

Stainless Steel Glass Clamps/Spigots

| | | | |
|---|---|--|---|
|  |  |  |  |
| HM-900 2500mm/ 8.2ft | HM-901 5000mm/ 16.4 ft | HM-902 12mm/0.47" | HM-903 2500mm/ 8.2ft |
|  |  |  |  |
| HM-904 45x45x 25 Flat | HM-905 45x45x42.4mm | HM-906 55x55xFlat | HM-907 55x55x48.3mm |
|  |  |  |  |
| HM-908 45x50x27 Flat | HM-909 45x63x42.4mm | HM-910 6mm Rubber | HM-911 12.10mm Rubber |
|  |  |  |  |
| HM-912 38/50x38mm | HM-913 38.50x 50mm | HM-914 50x50mm | HM-915 |











Stainless Steel Glass U-Channels/Connectors

| | | | |
|---|---|--|---|
|  |  |  |  |
| HM-916 42.4x24x24mm | HM-917 | HM-918 42.4mm | HM-919 42.4mm |
|  |  |  |  |
| HM-920 42.4x2mm | HM-921 42.4x2mm | HM-922 42.4x2mm | HM- 923 42.4x2mm |
|  |  |  |  |
| HM-924 42.4x2mm | HM-925 42.4x2mm | HM-926 42.4x2mm | HM-927 42.4x2mm |
|  |  |  |  |
| HM-928 42.4x2mm | HM-929 105mm | HM-930 100mm | HM-931 42.4mm |

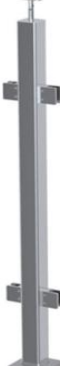
Stainless Steel Glass Connectors

| | | | |
|---|---|--|---|
|  |  |  |  |
| HM-932 ■ 40x40mm | HM-933 ■ 40x40mm | HM-934 ■ 108x108mm | HM-935 ■ 95x95mm |
|  |  |  |  |
| HM-936 ■ 40x40mm | HM-937 ■ 40x40mm | HM-938 ● 90° | HM-939 ● 135° |
|  |  |  |  |
| HM-940 ■ 40x40mm | HM-941 ■ 40x40mm | HM-942 ● 40x40mm | HM-943 ● 40x40mm |
|  |  |  |  |
| HM-944 ● 40x40mm | HM-945 ● 42.4mm | HM-946 ● Flat | HM-947 ● 42.4mm |

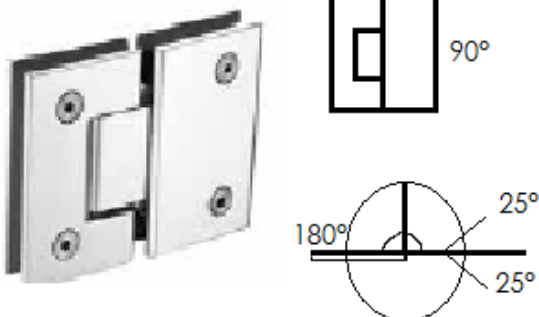
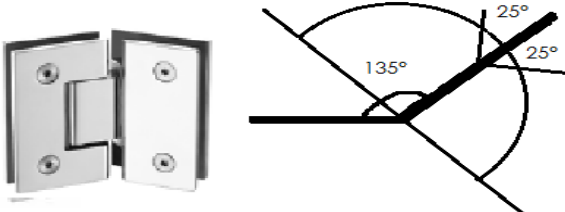
Stainless Steel Posts and Clamps

| | | | |
|---|---|--|---|
|  |  |  |  |
| HM-948 • PLAIN | HM-949 • 2 CLIP | HM-950 • 4 CLIP | HM-951 • CORNER |
|  |  |  |  |
| HM-952 ■ 2CLIP | HM-953 ■ 4 CLIP | HM-954 ■CORNER | HM-955 ■ PLAIN |
|  |  |  | |
| HM-956 | HM-957 | HM-958 10 or 12MM (90°) | |
|  | |  |  |
| HM-959 10 or 12MM (45°) | | HM-960 | HM-961 |





Shower Handles and Plastic Tubing

| | | | |
|---|---|--|---|
|  |  |  |  |
| HM-961 | HM-962 12MM | HM-963 12MM | HM-964 |
|  |  |  |  |
| HM-965 | HM-966 | HM-967 | HM-968 |
|  |  |  |  |
| HM-969 Fits 10mill glass | HM-970 Fits 10mill glass | HM-971 Fits 10mill glass | HM-972 Fits 10mill glass |
|  |  |  |  |
| HM-973 Fits 12MM/metre | HM-974 | HM-975 for tube | HM-976 12MM |











Miscellaneous

| | | | |
|---|--|---|--|
|  |  |  |  |
| HM-977 38x38/ 38x50mm | HM-978 | HM-977 50/55/60mm for wood | HM-978 |
|  |  |  |  |
| HM-979 | HM-980 | HM-981 | HM-982 |
|  30ml |  |  |  |
| HM-983 | HM-984 | HM-985 | HM-986 |

Wooden Posts

| | | | | |
|---|---|---|---|---|
|  |  |  |  |  |
| HM-1120 Base 3-1/2" 4" 5" | HM-1120 3-1/2" 4" 5" | HM-1130 3-1/2" 4" 5" | HM-1140 3-1/2" 4" 5" | HM-1180 3-1/2" 4" 5" |

Handrails, Nosing, Treads

| | | | | |
|---|--|--|---|---|
| HM-1  | HM-2  | HM-4  | HM-5  | HM-7  |
| HM-10  | HM-11 Nosing: Maple 4"  | HM-12 Nosing: Oak 4"  | HM-13 Nosing: Oak 4" and 5"  | HM-14 Tread Left or Right  |



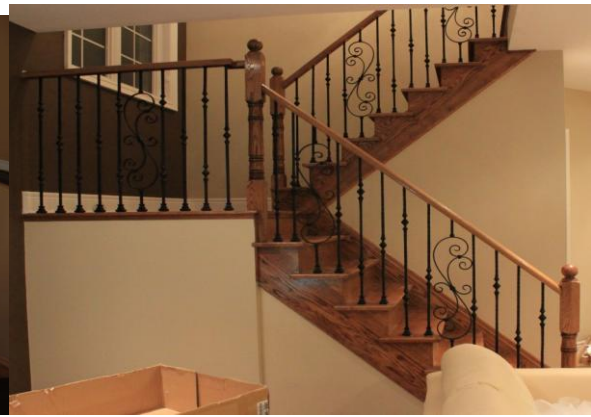
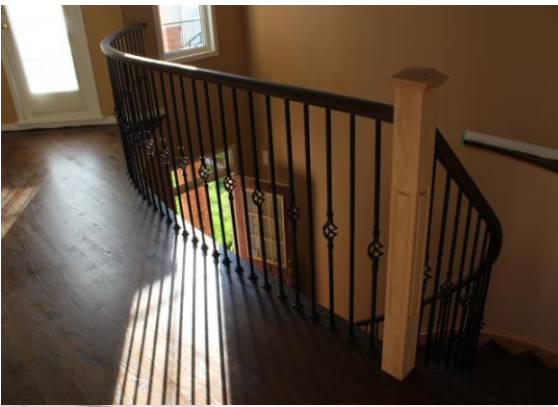











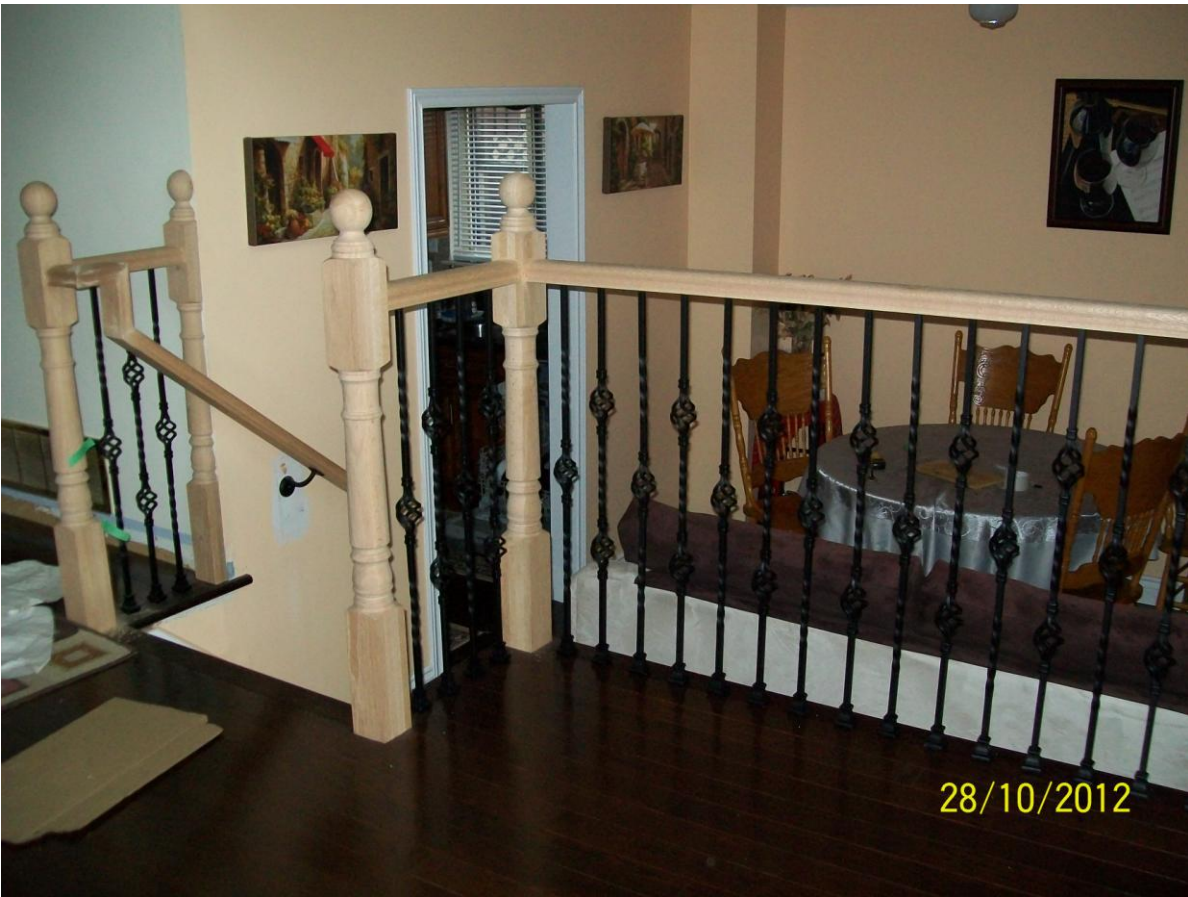











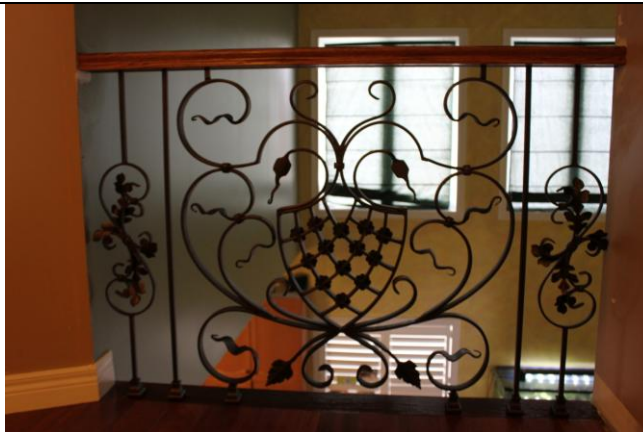
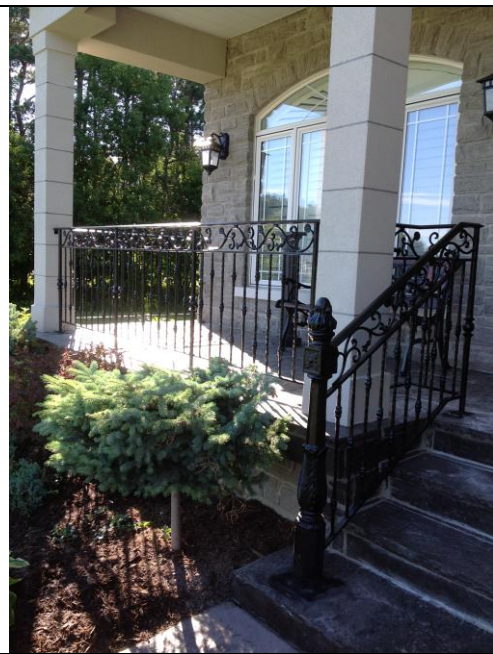

Great Wall Ornamental Ltd

Address: 96 Bowes Road Unit 4, Concord Ont .L4K 1J7

Tel:(647)547-6621, Cell: (416)803-3361; Fax (647)547-6621

[E: Greatwalltrading@rogers.com](mailto:Greatwalltrading@rogers.com)

www.Greatwallornamental.com

Great Wall Trading Ltd Tel: (647)-547-6621/ Cell: (416)-803-3361 p.66